

VA-7080

Terminal Unit Actuators Series

Product Bulletin

The VA-7080 Terminal Unit Actuators Series provide ON/OFF and DAT control in HAVC application.

The compact design of these actuators make them suitable for installations in confined spaces, such as fan-coil applications.

The VA-7080 actuators are designed for field mounting onto VG3000 terminal unit valve, VP1000 pressure independent valve and the discontinued series VG6000, V5000, VG4000, and VG5000 (see pertinent product bulletins).

Moreover, thanks to an innovative fixing system, the VA-7080 is suitable for almost all the terminal unit valves in the market.



Features and Benefits

- **Low and line voltage models available**
Flexible applications
- **Suitable to Johnson Controls and almost all of terminal unit valve on the market**
No limits in valve selection and retrofitting
- **Easy mounting solution**
Easy to install, no expert required, just one click to snap onto the valve adapter
- **Compact design**
Ideal for installation in confined spaces (fan coils, etc.)
- **Can be mounted after valve body is installed**
Easier to install. Allows more flexibility in actuator selection
- **Actuator stroke indicator highly visible**
Actuator stroke visible in any direction, in confined space and in dark environment
- **IP54**
Installation permitted in any direction

Ordering Information

Actuators

Codes	Power Supply	Control Type	Factory Setting	Mounting Thread	Auxiliary Switches	
VA-7088-21	24 VAC/DC +20% - 10%	ON/OFF	Normally Closed (Stem retracts when energized)	M30 x 1.5	---	
VA-7087-21			Normally Open (Stem extends when energized)			
VA-7081-21			Normally Closed (Stem retracts when energized)	M28 x 1.5		
VA-7080-21			Normally Open (Stem extends when energized)			
VA-7088-23	230 VAC ± 10%		Normally Closed (Stem retracts when energized)	M30 x 1.5		
VA-7087-23			Normally Open (Stem extends when energized)			
VA-7081-23			Normally Closed (Stem retracts when energized)	M28 x 1.5		
VA-7080-23			Normally Open (Stem extends when energized)			
VA-7088-21C	24 VAC/DC +20% - 10%		Normally Closed (Stem retracts when energized)	M30 x 1.5		•
VA-7088-23C	230 VAC ± 10%		Normally Closed (Stem retracts when energized)			•

Accessories (to be ordered separately)

Codes	Description
VA50	Adapter for VG6000
VA64	Adapter for VP1000















Spare Parts

Codes	Description
VA80	Standard Adapter M30 x 1.5 for VG3000 and V5000, included in the product package
VA17	Standard Adapter M28 x 1.5 for VG5000 and VG4000, included in the product package

Adapter Selection Guide for Johnson Controls Valves

Valves	Actuators	Adapter	Note
VG3000	VA-7087-2x	---	Included in the actuator packaging
	VA-7088-2x	---	
V5000	VA-7087-2x	---	
	VA-7088-2x	---	
VG6000	VA-7087-2x	VA50	To be ordered separately
	VA-7088-2x	VA50	
VP1000	VA-7080-2x	VA64	
	VA-7081-2x	VA64	
VG5000	VA-7080-2x	---	Included in the actuator packaging
	VA-7081-2x	---	
VG4000	VA-7080-2x	---	
	VA-7081-2x	---	

Valve - Actuator Operating Schematics

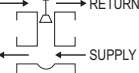
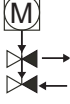
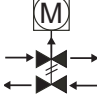
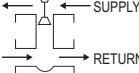
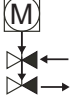
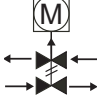
Valve Type	Stem Movement / Flow	
	Actuator Stem Extended	Actuator Stem Retracts
 <p>Two Way PDTC (NO)</p>		
 <p>Two Way PDTO (NC)</p>		
 <p>Three Way MIXING</p> 		
 <p>Three Way DIVERTING</p> 		
 <p>Three Way MIXING + Bypass</p>		
 <p>Three Way DIVERTING + Bypass</p>		

Mounting Instructions

When mounting the actuator on the valve, please follow the instruction below:

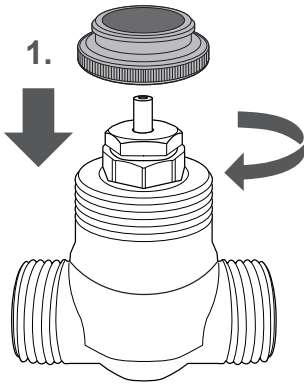

Screw the adapter manually onto the valve

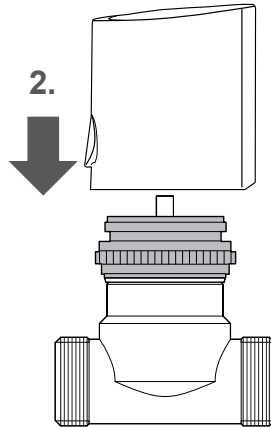

Place the VA-7080 vertically on the valve adapter

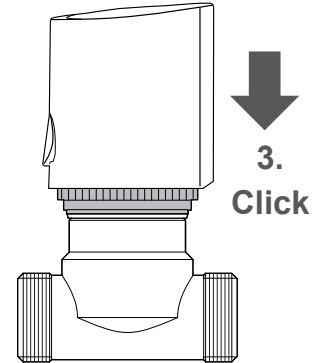

Push the VA-7080 onto the valve adapter until click

Mounting Position

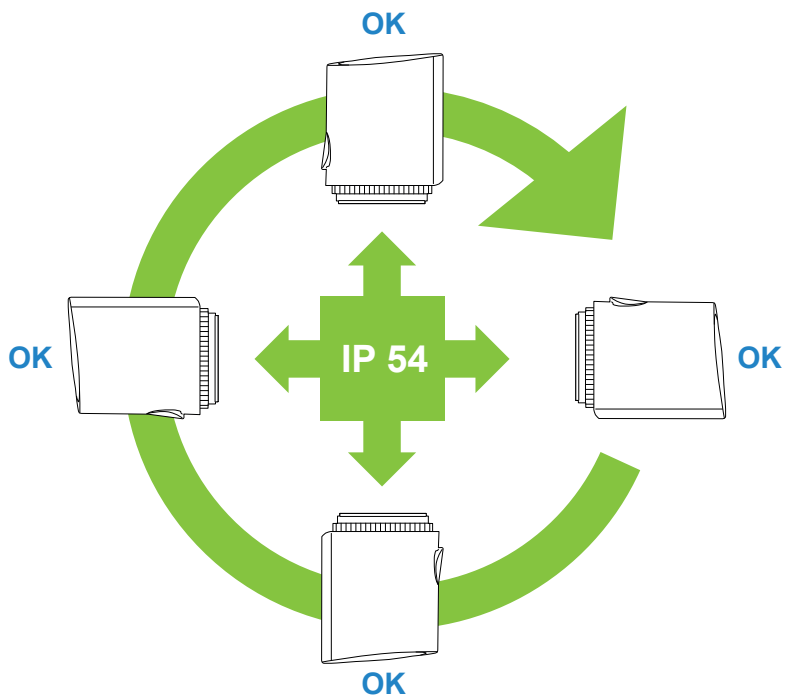

Wiring Instructions

When servicing make sure that:

- The electric supply to the actuator is switched off to avoid possible damage to the equipment, personal injury or shock
- Make sure that the line power supply is in accordance with the power supply specified on the actuator
- All wiring should conform to local codes and must be carried out by authorized personnel only
- Do not touch or attempt to connect or disconnect wires when electric power is on
- Do not open or attempt to repair, contact your Johnson Controls dealer

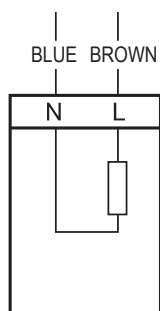

Wiring diagram

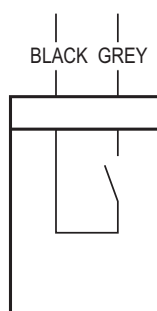

Auxiliary switch wiring diagram

Auxiliary contacts

In case of the normally closed version, the valve is opened steadily by the ram motion upon switching on the operating voltage and after expiry of the dead time. The integrated micro switch is switched with a travel path of approx. 2 mm.

After the operating voltage is cut and after expiry of the hold time the valve is closed evenly by the closing force of the compression spring. The integrated switch is closed after an actuator travel of approx. 2 mm.

The closing force of the compression spring is matched to the closing force of commercially available valves and keeps the valve closed when de-energised.

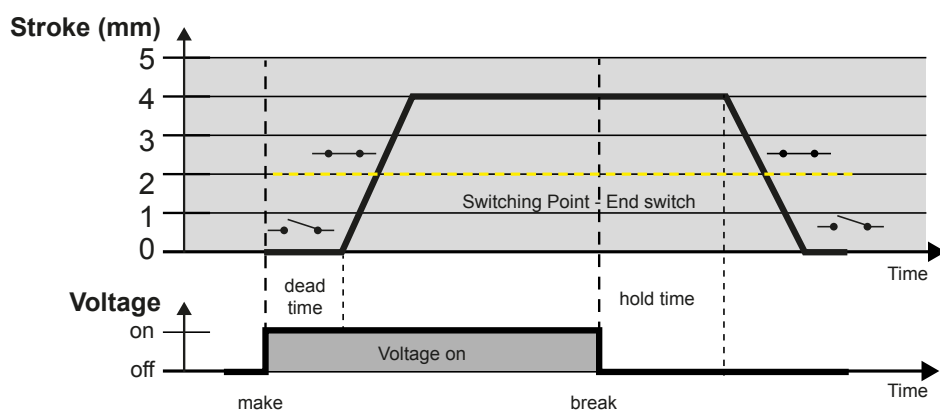

Example with respect to the travel path of 4 mm. The characteristic curves of the travel path of 5 mm result from this.

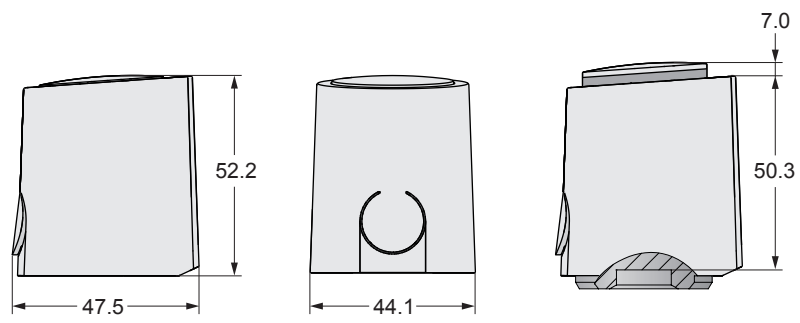
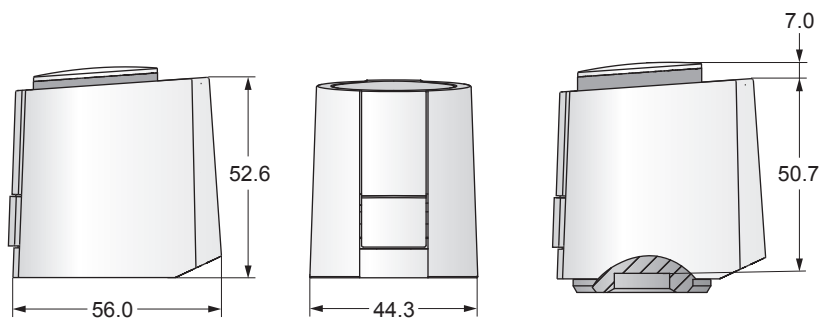
Dimensions (in mm)**VA-708x****VA-7088-2xC**

Technical Specifications

Models	VA-708x-23	VA-708x-21
Type of Motor	Thermal ("Wax" power element)	
Type of Control	ON/OFF or DAT	
Action	Normally Closed (stem retracts when energized) Normally Open (stem extends when energized)	
Supply voltage (50/60 Hz)	230 VAC \pm 10%	24 VAC/VDC +20%...-10%
Power Consumption		
<i>Continuous</i>	1 W	1 W
<i>Max Inrush Current</i>	<550 mA during 100 ms. max	<300 mA during max 2 min.
Switching Current for Micro Switch	5 A resistive load, 1 A inductive load	3 A resistive load, 1 A inductive load
Nominal Force	100 N + 5%	
Nominal Stroke	5 mm	
Running Time	~4 min	4.5 min
Electrical connection	1.5 m PVC cable, wire sections 2 x 0.75 mm ²	
Protection class	II	III
Ingress Protection Rating	IP 54 (EN60529)	
Connection to Valves	M28 x 1.5 (VA-7081 and VA-7080) M30 x 1.5 (VA-7088 and VA-7087)	
Max Valve Operating Temperature	100°C	
Ambient Operating Condition	0 to 60°C, non condensing	
Ambient Storage Condition	-25 to 60°C, non condensing	
Weight (excl. packaging)	0.1 Kg	
CE Compliance	Johnson Controls declares that these products are in compliance with the essential requirements and other relevant provisions of:	
	EMC Directive and Low Voltage Directive	EMC Directive

The performance specifications are nominal and conform to acceptable industry standards. For application at conditions beyond these specifications, consult the local Johnson Controls office. Johnson Controls shall not be liable for damages resulting from misapplication or misuse of its products.